

25W Dimmable Driver

DIMD-2524

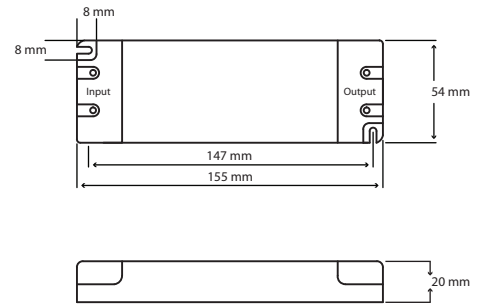

COM



Product Reference: **DIMD-2524**

FOSS Mains Dimmable Drivers are compatible with the majority of Leading & Trailing edge dimmers and automated lighting systems with a dimming capacity of 5 - 100%; for further information please contact us on 0203 198 1908.

Technical Specification:

Output	Output Power DC Voltage Dimming Capacity Voltage Tolerance Rated Current	25w 24v 5 - 100% ± 0.5V 1.04A
Input	Input Voltage Range AC Frequency Power Factor Efficiency AC Current Leakage Current	180 - 240VAC 47 - 63 Hz >0.65 >85% 0.21A <0.70mA/220VAC
Environment	Working Temp Relative Humidity Vibration	-40°C - +60°C 20 - 90% 10 - 500Hz/ 2g, 10 minutes
Safety & EMC	Isolation Voltage EMI Safety EMC Emission EMC Immunity	In/ Out 3750VAC EN55015 Class B EN61347-1, EN61347-2-13 ≥ EN55015, EN61000-3-2,3 (50% Loading) EN6100-4-2,3,4,5,6,11 (Surge 4KV)
Size	Dimensions (mm)	155 x 54 x 20 mm